

1. Name and Parts

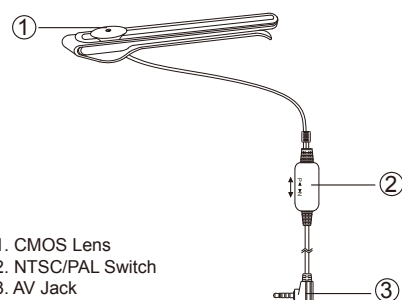

2. Package Content

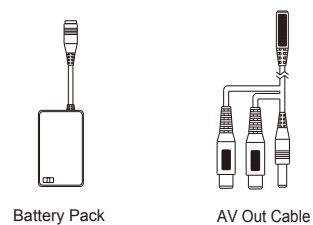

1

3. Select Video Signal System

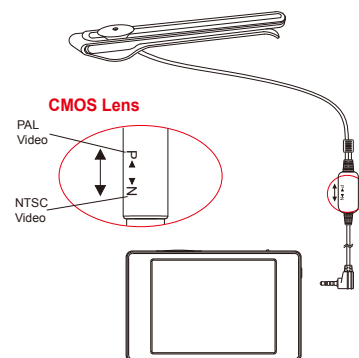

1. Make sure the video system is selected before turning on the DVR.
2. On the control switch,
N - NTSC System
P - PAL System

2

4. Camera Setup Illustration

Connection with a portable DVR:

1. Select NTSC/PAL on the camera.
2. Plug in the camera into CAM IN socket on the DVR.
3. Power on DVR and press REC button to start recording.

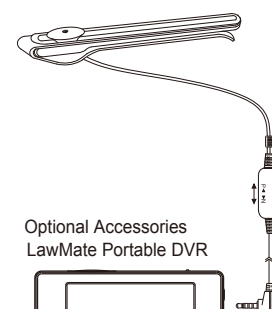

3

Connection with AV Out cable:

If you do not use LawMate portable DVR and would like to connect CM-TC10 to your own DVR or display device, you could use AV Out cable to make the connection.

1. Install the device as illustration shown below.
2. Connect yellow and red cables to your DVR or display.
3. Connect 9V power-cord to your power supply.
*If you do not have the power supply, you can use our battery holder to supply the power. Slide the back cover of battery holder to open the battery tray. Insert a PP3 (9V) battery into battery tray. Switch to ON position.
4. Captured images are automatically shown on the connected DVR or display.

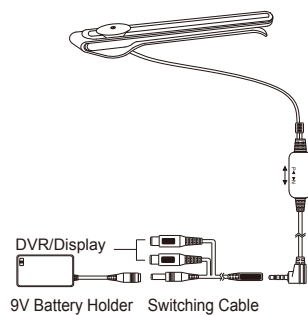

4

5. Connection with Wireless Equipment

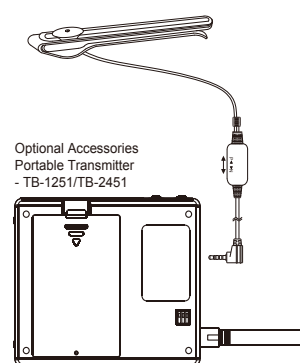

1. Camera can also be connected with RF wireless equipment.
2. Connect AV jack to portable transmitter.
3. Connect DVR or any recording device with portable receiver.
4. Set transmitter and receiver at the same frequency or channel.
5. Turn on receiver's power.
6. Captured images will be shown on receiver side.
7. Note that receiver should be connected with external LCD / TV in order to display captured images.

5

C11741 Tie Clip Cover Camera Quick Guide

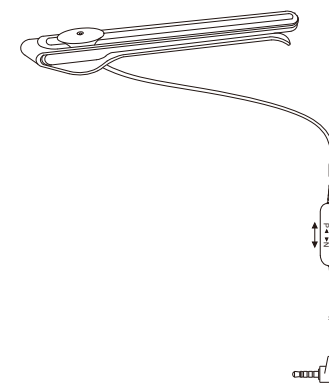

®