

1. Names and Parts

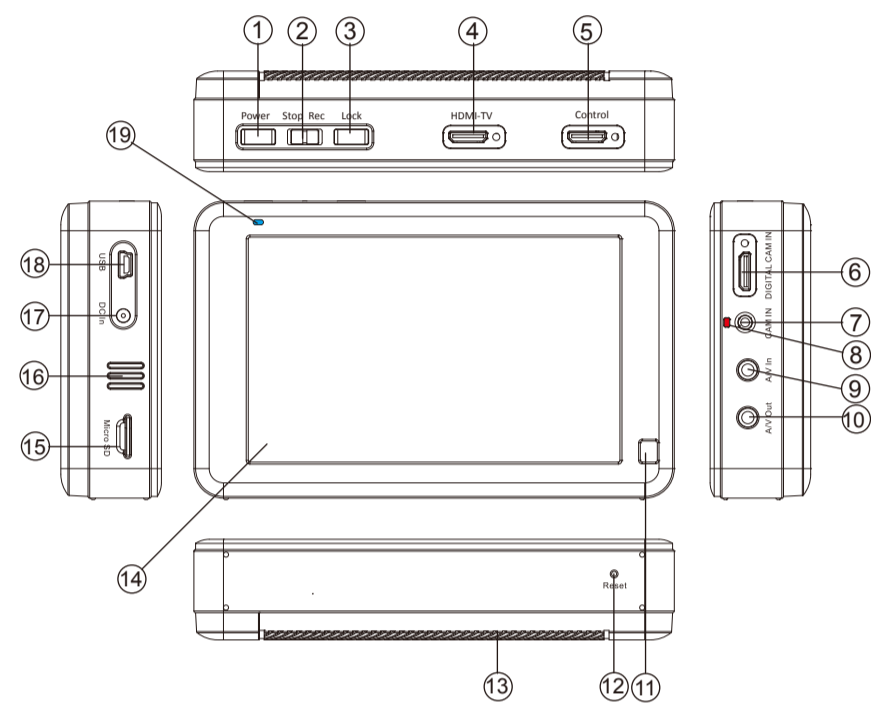

- | | | |
|--------------------|---------------------|-------------------------|
| 1. Power Button | 7. Analog Cam In | 13. Battery Compartment |
| 2. Stop/Rec Button | 8. Camera LED | 14. 5" Touch Screen |
| 3. Screen Lock | 9. A/V In | 15. Memory Card Slot |
| 4. HDMI Out | 10. A/V Out | 16. Speaker |
| 5. Control Port | 11. Infrared Sensor | 17. DC In |
| 6. Digital Cam In | 12. Reset Button | 18. USB Port |
| | | 19. LED Status Bar |

1

2. Package Content

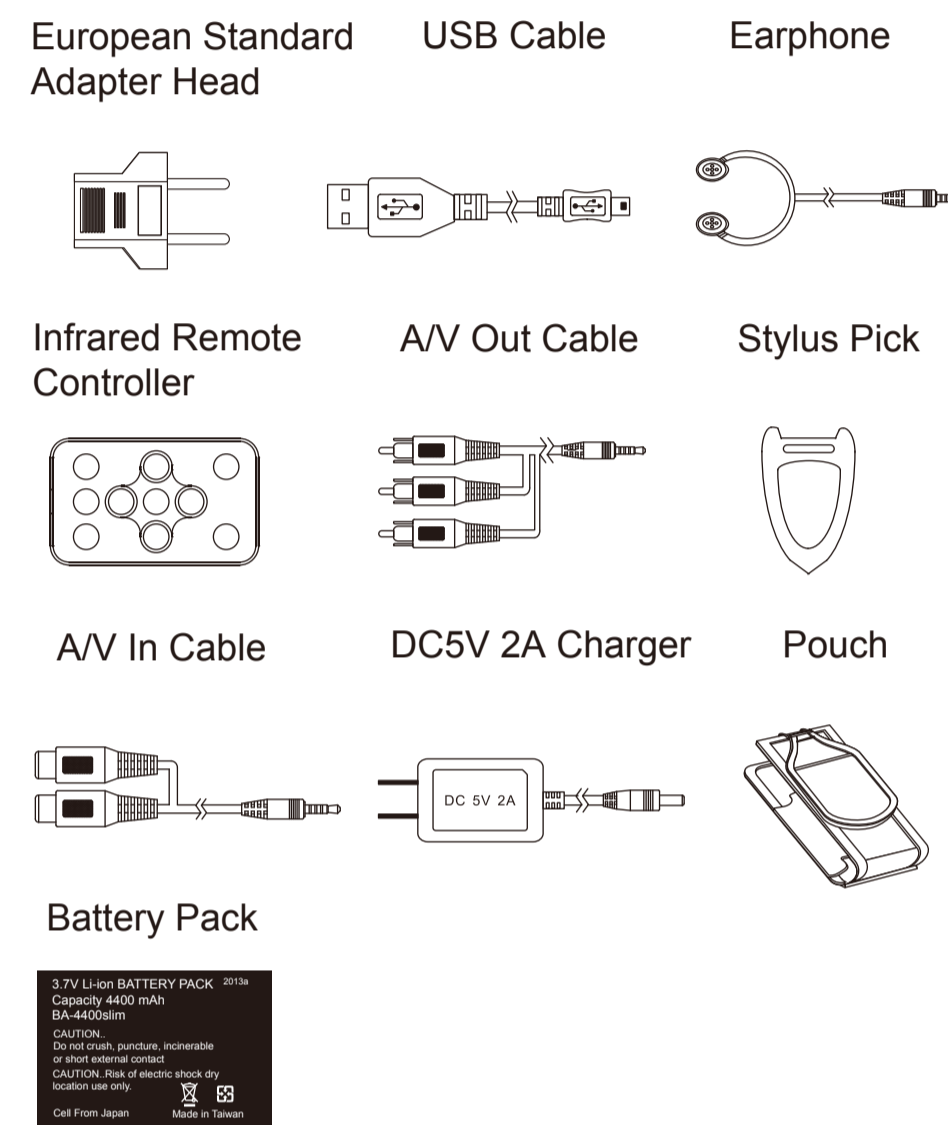

2

3. Install and Charge Battery

- 3.1. Remove the Battery Cover
Press ① and slide the rear cover following red arrow pointed direction

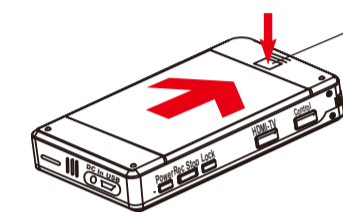

- 3.2. Insert the Battery
Align the golden contacts of the supplied battery with corresponding connectors on the PV-1000Touch, then slide in the battery with a beveled angle until it fits into place.

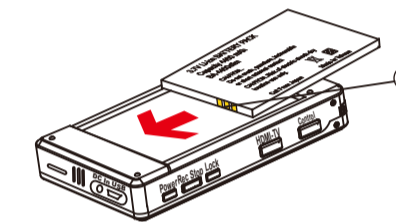

- 3.3. Charging the battery
Plug the supplied DC 5V power adapter to an AC wall outlet then connect the other end of the power cord to the DC IN socket ③ on the side of PV-1000Touch. The red LED indicator will illuminate on while the battery is charging.
The red LED will turn off when the device is fully charged.

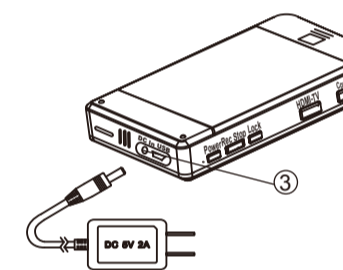

3

5. PV-1000Touch Connection Illustration

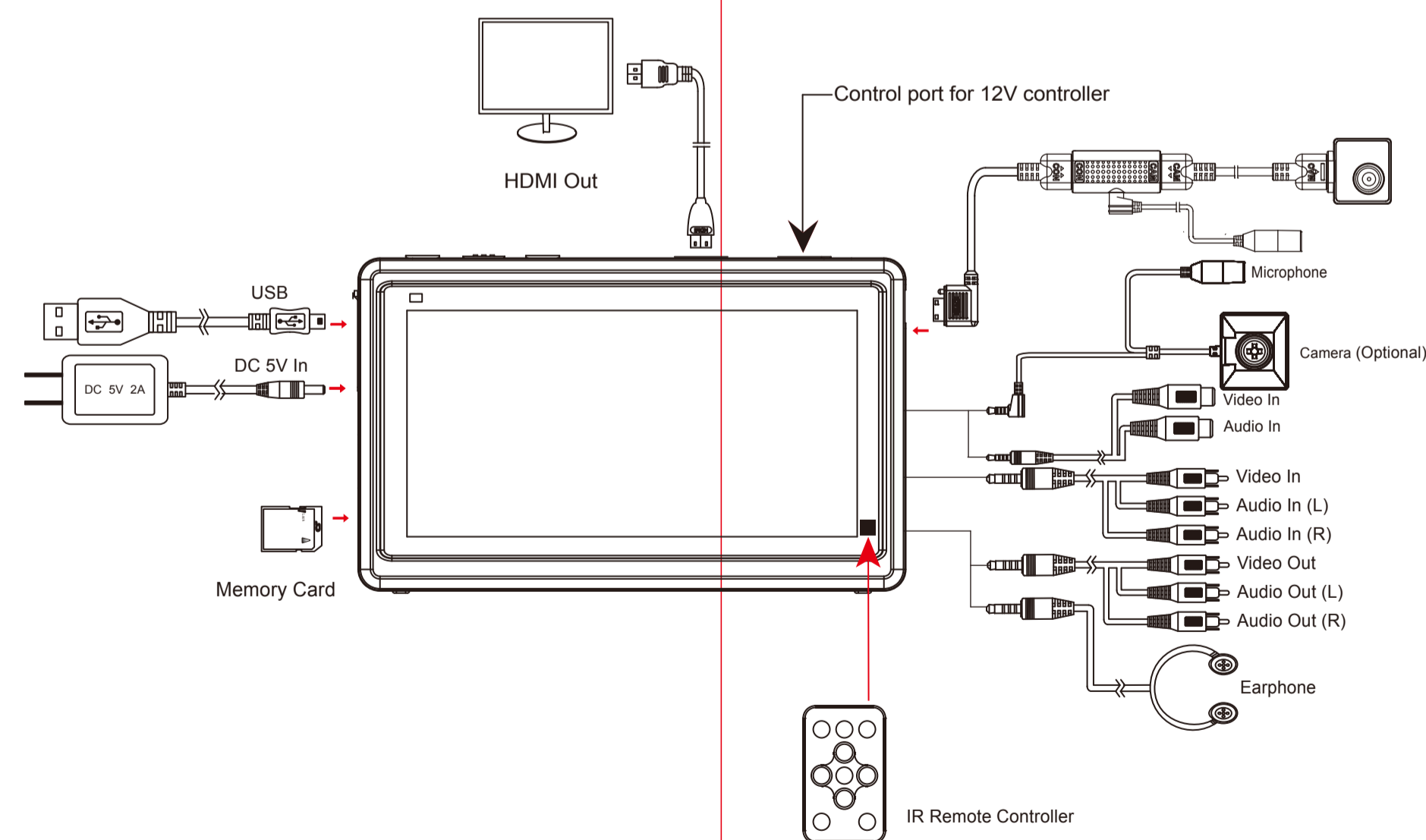

4

5

PV-1000Touch 5" Touch Screen Full HD Recorder Operation Manual

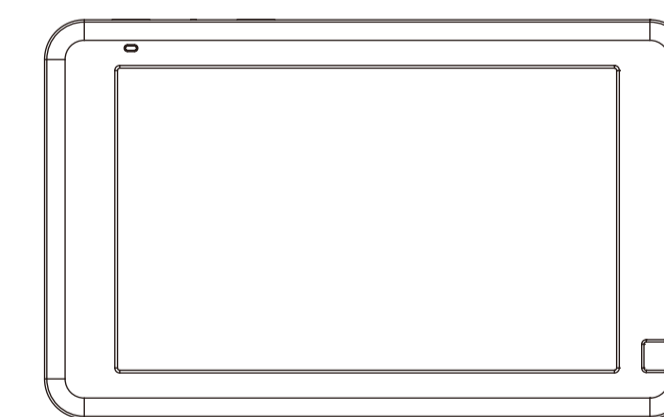

LawMate, innovation never stops

LawMate[®]

V1.0