

## 1. Names and Parts

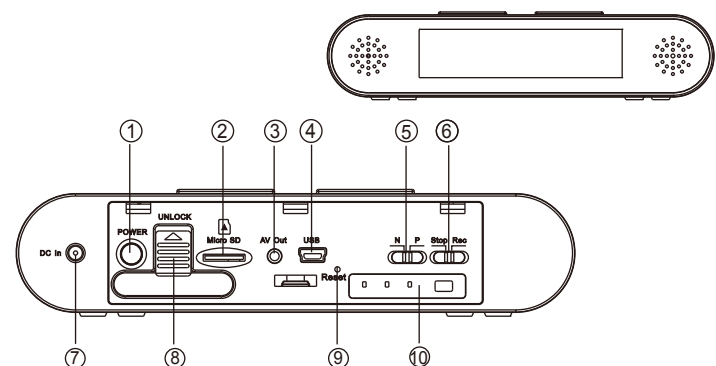

- |                     |                    |                         |
|---------------------|--------------------|-------------------------|
| 1. Power Button     | 4. USB Socket      | 7. DC In Jack           |
| 2. Memory Card Slot | 5. NTSC/PAL Switch | 8. Battery Slot         |
| 3. A/V Out Port     | 6. Stop/Rec Button | 9. Reset Button         |
|                     |                    | 10. LED Bar and IR Port |

\*No Microphones are available for USA territory.

## 2. Package Content

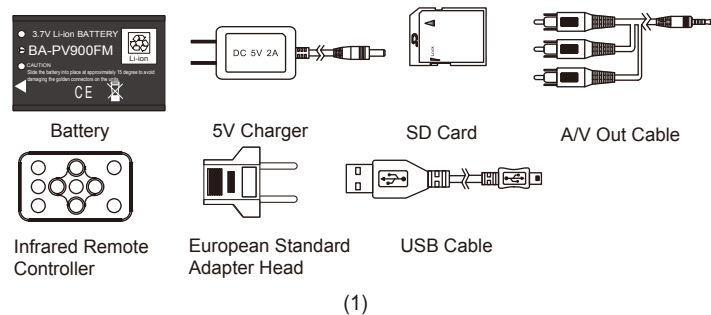

(1)

## 3. Charge Battery

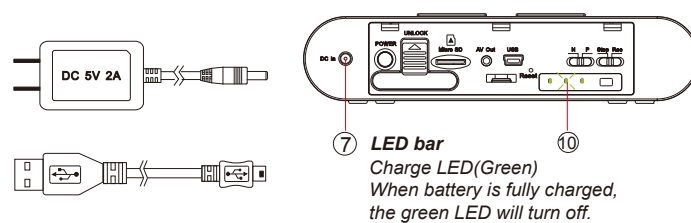

There are two ways to charge the battery.

### ① Connect 5V adaptor to DVR

1. Remove the back cover from the DVR and connect the charger plug to the DC In Jack (7).
2. Plug the power cord of the charger to an AC wall outlet. The charging starts automatically.
3. The LED bar (10) will illuminate green to show the device is in charging mode. Charging time required is 3 to 4 hours.
4. After charging is completed, green light turns off automatically.
5. Users may charge the battery while recording.

### ② Connect USB cable to DVR

1. Remove the back cover from the DVR and connect the supplied USB cable into the device.
2. Plug the USB cable to a PC, the green Charge LED of the device will illuminate to show the charging is in process.
3. Green LED will turn off when the battery is fully charged.

(2)

## 4. Setting

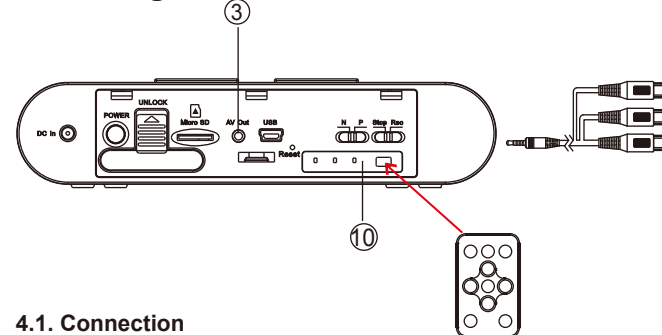

### 4.1. Connection

Connect AV/Out Cable to the A/V out port (3) on the device and connect the RCA jacks to the monitor.

### 4.2. Operated by infrared controller

Aim the IR remote controller to the IR port (10) on the DVR and edit settings by the remote controller.

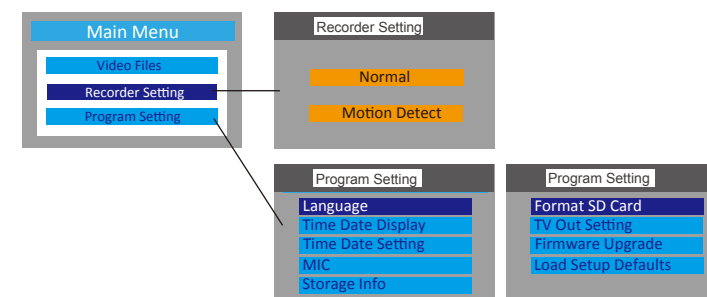

(3)

## 6. Retrieve Files from DVR

There are two ways to read the retrieve video files.

- 6.1. Use memory card reader to retrieve video files.
- 6.2. With the device powered on and memory card inserted, connect the device to PC by USB cable. It will be recognized by PC as an external drive for user to retrieve the files.

## 7. Digital Clock Time Setting

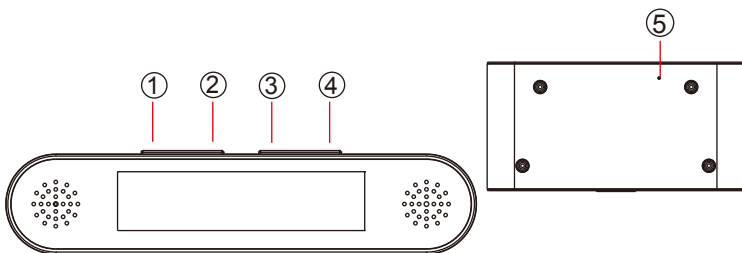

- 7.1. Insert a safety pin into the reset button (5) before operation.
- 7.2. Long press (3) for three seconds to access its time setting mode.
- 7.3. Press (1) or (2) to set hours and press (3) again to set minutes.  
To exit time setting mode, press (3).
- 7.4. Press (1) to switch the displaying to 12 or 24 hour format.
- 7.5. Press (4) to activate the blue LED backlight.

(4)

## 8. Operation

Please note, before recording memory card needs to be formatted on the PC with SD card reader or on the monitor when using AV-Out cable.

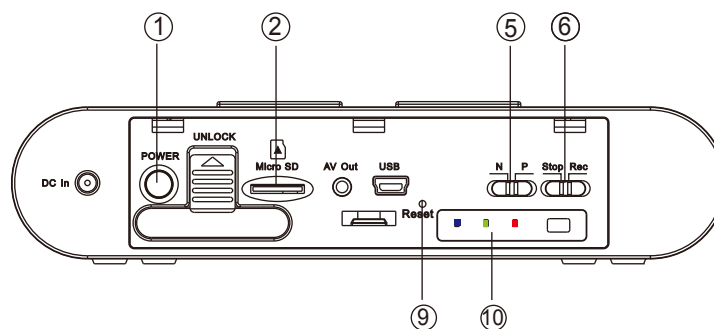

- 8.1. Insert memory card into the card slot (2).
- 8.2. Power on/off the DVR by pressing power button (1).
- 8.3. Switch (5) to set NTSC or Pal system
- 8.4. Switch (6) to Rec/Stop to start or stop recording.
- 8.5. Insert a safety pin into the reset button (9) to reset DVR.
- 8.6. LED indicator  
Blue: DVR is powered on  
Green: DVR is in charging mode.  
Red: DVR is in recording mode.

(5)

## DVR259 Digital Clock DVR Quick Guide

